

TABLE OF CONTENTS

	Page
CHAPTER I INTRODUCTION	1-1
1-1. GENERAL DESCRIPTION	1-1
1-2. MANUAL COVERAGE	1-1
SPECIFICATIONS	1-2
CHAPTER II INSTALLATION	2-1
2-1. UNPACKING	2-1
2-2. TUBE AND CHIMNEY INSTALLATION	2-1
2-3. LOCATION	2-2
2-4. POWER REQUIREMENTS	2-2
2-5. JUMPER CONNECTIONS	2-2
2-6. ANTENNA REQUIREMENTS	2-2
2-7. LOW PASS FILTER	2-2
2-8. MATCHING NETWORK	2-2
2-9. GROUND REQUIREMENTS	2-3
2-10. EXCITER REQUIREMENTS	2-3
2-11. TRANSMITTING AGC	2-3
2-12. VOX RELAY	2-3
CHAPTER III OPERATION	3-1
3-1. GENERAL	3-1
3-2. TUNING PROCEDURE	3-1
3-3. CW AND RTTY TUNING	3-1
3-4. SSB AND AM TUNING	3-3
3-5. OPERATION	3-3
3-6. CW AND RTTY OPERATION	3-3
3-7. SSB OPERATION	3-3
3-8. AM OPERATION	3-4
3-9. SWR CALCULATION	3-4
3-10. OPERATION ON ACCESSORY FREQUENCIES	3-4

TABLE OF CONTENTS (continued)

	Page
CHAPTER IV	THEORY OF OPERATION 4-1
4-1.	INPUT 4-1
4-2.	TRANSMITTING AGC 4-1
4-3.	STANDBY CUTOFF BIAS 4-1
4-4.	OUTPUT 4-1
4-5.	WATTMETER 4-1
CHAPTER V	MAINTENANCE 5-1
5-1.	SERVICE DATA 5-1
5-2.	PARTS ORDERING 5-1
5-3.	AMPLIFIER 5-1
5-4.	DISASSEMBLY 5-1
5-5.	FRONT PANEL REMOVAL 5-1
5-6.	CLEANING 5-2
5-7.	LUBRICATION OF BLOWER MOTOR 5-2
5-8.	INPUT SWITCH DRIVE BELT REPLACEMENT 5-2
5-9.	TUBE REPLACEMENT 5-2
5-10.	TEST EQUIPMENT 5-2
5-11.	AMPLIFIER TROUBLESHOOTING 5-2
5-12.	TUBE CHECK 5-3
5-13.	ALIGNMENT PROCEDURES 5-3
5-14.	INPUT COIL ADJUSTMENT 5-3
5-15.	METER ADJUSTMENT 5-4
5-16.	WATTMETER CALIBRATION 5-4
5-17.	NULL ADJUSTMENT 5-4
5-18.	300 WATTS REFLECTED 5-4
5-19.	300 WATTS FORWARD 5-5
5-20.	3000 WATTS FORWARD 5-5
5-21.	KNOB POINTER ALIGNMENT 5-5
5-22.	POWER SUPPLY 5-5
5-23.	CIRCUIT BREAKER RESET 5-5
5-24.	REMOVING BOTTOM COVER 5-5
5-25.	REMOVING TOP COVER 5-6
5-26.	POWER SUPPLY TROUBLESHOOTING 5-6

LIST OF ILLUSTRATIONS

Figure		Page
1-1.	MODEL L-4B LINEAR AMPLIFIER	1-2
2-1.	REAR CHASSIS CONNECTORS	2-4
2-2.	JUMPER CONNECTIONS FOR 120 VOLT OPERATION	2-5
2-3.	JUMPER CONNECTIONS FOR 240 VOLT OPERATION	2-5
2-4.	CONNECTING THE AC-4 POWER SUPPLY AND THE R. L. DRAKE LINE OF COMPATIBLE EXCITERS	2-6
2-5.	CONNECTING THE AC-3 POWER SUPPLY AND THE R. L. DRAKE LINE OF COMPATIBLE EXCITERS	2-6
2-6.	VIEWING ANGLE OPTIONS.	2-7
3-1.	FRONT PANEL CONTROLS.	3-2
3-2.	PLATE VOLTAGE AND PLATE CURRENT VS 1,000 WATTS DC INPUT POWER	3-5
3-3.	SWR NOMOGRAPH.	3-5
5-1.	COMPONENT LOCATIONS, TOP VIEW	5-7
5-2.	COMPONENT LOCATIONS, BOTTOM VIEW	5-8
5-3.	CONNECTIONS FOR GRID CURRENT METER CALIBRATION	5-9
5-4.	MODEL L-4B POWER SUPPLY SCHEMATIC DIAGRAM	5-9
5-5.	MODEL L-4B LINEAR AMPLIFIER SCHEMATIC DIAGRAM	5-9

CHAPTER I

INTRODUCTION

1-1. GENERAL DESCRIPTION.

The R. L. Drake Model L-4B Linear Amplifier offers continuous 2000 Watts PEP on SSB, and 1000 Watts DC on CW, AM (controlled carrier) and RTTY operation covering the ham bands 80 through 10 meters. All frequencies 3.2 to 30 MHz may be covered with modification of the input circuit.

The L-4B uses 2 zero-bias triodes in a Class B grounded-grid circuit configuration that utilizes RF negative feedback for lower odd-order distortion products. As shipped from the factory, these tubes will be one of the following listed parts, which are interchangeable but which are furnished in pairs only:

Amperex 8802/3-500Z

Amperex 8163

Eimac 3-400Z

Eimac 3-500Z

The tubes are forced air cooled by a quiet, low velocity, high volume internal blower.

A transmitting AGC circuit controls the exciter gain to allow the highest average power without peak clipping. An internal changeover relay feeds

the antenna through when the L-4B is turned off. A pair of relay contacts bias the output tubes to cutoff, eliminating unwanted heat and diode noise when receiving. Two taut-band suspension meters indicate plate current, grid current, plate voltage, RF output power, and RF reflected power. The separate solid state Power Supply requires no warm-up period and provides excellent dynamic and static voltage regulation.

1-2. MANUAL COVERAGE.

This manual is presented in 5 chapters with supporting illustrations and is arranged for the convenience of the operator and service technician as follows:

- | | |
|-------------|--|
| Chapter I | Introduction (self explanatory). |
| Chapter II | Installation. Describes the procedures to be followed prior to operation. |
| Chapter III | Operation. Illustrates and describes front panel controls and describes tune-up and operation in SSB, CW, RTTY, TUNE and AM modes. |
| Chapter IV | Theory of Operation. Describes all critical circuits and networks. |
| Chapter V | Maintenance. Provides maintenance instructions, troubleshooting and parts ordering information. |

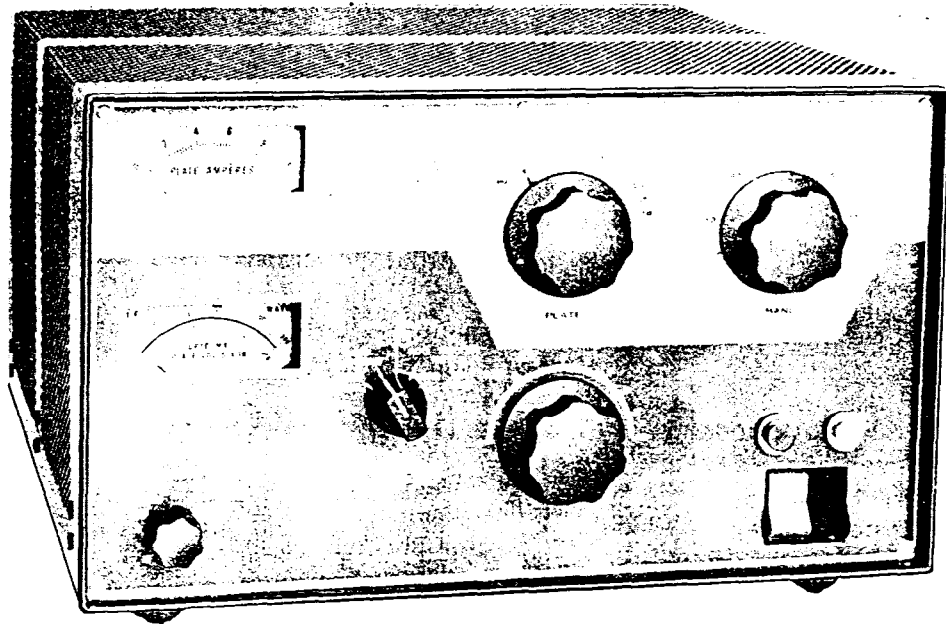

Figure 1-1. Model L-4B Linear Amplifier

SPECIFICATIONS

Frequency Coverage:	Ham bands 80 through 10 meters. All frequencies 3.2 to 30 MHz may be covered with some modification of the input circuit.
Plate Input:	2000 Watts PEP on SSB and 1000 Watts DC on CW, AM and RTTY.
Drive Requirements:	100 Watts PEP on SSB and 75 Watts on CW, AM and RTTY.
Input Impedance:	50 Ohms.
Output Impedance:	Adjustable pi-network matches 50 Ohm line with SWR not to exceed 2:1.
Intermodulation Distortion Products:	In excess of -33 dB.
Wattmeter Accuracy:	300 Watts forward and reflected, \pm (5% of reading + 3 Watts). 3000 Watts forward, \pm (5% of reading + 30 Watts).
Power Requirements:	240 Volts 50-60 Hertz 15 Amperes, or 120 Volts 50-60 Hertz 30 Amperes.
Tube Complement:	Two of 3-500Z or 8802/3-500Z or 8163 or 3-400Z.
Dimensions:	Amplifier 13-15/16 in. W x 7-7/8 in. H x 14-5/16 in. D. 35.4 cm W x 20 cm H x 36.3 cm D. Power Supply 6-3/4 in. W x 7-7/8 in. H x 11 in. D. 17 cm W x 20 cm H x 28 cm D.

CHAPTER II

INSTALLATION

WARNING

The L-4B has been designed incorporating several interlocks to prevent dangerous electrical shock. However, it is possible to disconnect the high voltage terminal while the L-4B is turned on. This is **EXTREMELY DANGEROUS** and never should be attempted for any reason. When disassembling the L-4B, the high voltage terminal should be disconnected **LAST** and at reassembly the high voltage terminal should be connected **FIRST**. The L-4B and its Power Supply can be installed and serviced in complete safety if the instructions in this manual are followed explicitly.

2-1. UNPACKING.

The L-4B Linear Amplifier is shipped from the factory in 3 separate cartons; 1 contains the Amplifier, 1 contains the Power Supply and the third contains the tubes and chimneys and the miscellaneous hardware. Carefully unpack all 3 cartons and examine their contents for evidence of shipping damage. If any damage is discovered, notify the transportation company that delivered the equipment. Be sure to keep the cartons and packing material as the transportation company will want to examine them. Keep the cartons and packing even if no shipping damage occurs. Having the original cartons available simplifies repacking the equipment for storage or to return it to the factory for service. Inspect the packing material closely before storing it to be sure that none of the accessory hardware has been overlooked. The dismantled components and accessory hardware shipped with the L-4B should be checked against the following list.

- a. 2 Tubes (Amplifier V1 and V2)
- b. 2 Chimneys (for Tubes)
- c. 2 Plate Caps (for Tubes)
- d. 2 Setscrews (for Plate Caps)

- e. 2 Parasitic Chokes (Note TOP Label)
- f. Machine Screws (connect Chokes to Caps)
- g. 2 Internal Tooth Lock Washers (connect Chokes to Caps)
- h. 2 Cables (1 Vox Relay, 1 Transmit AGC)
- i. 1 Plug, 2-Pin (Vox Relay)
- j. 1 Allen Wrench (Fits Setscrews Above)
- k. 2 Resistors, 0.82 Ohm, 2 Watts (Replacement spares for Power Supply R12)
- l. 2 Threaded Studs (For Viewing Option C)
- m. 2 Rubber Feet (For Viewing Options B and C)
- n. 2 Hex Nuts (To attach Rubber Feet)
- o. 1 Instruction Manual (READ IT)
- p. 1 Warranty Registration Card
- q. S.W.R. Calculator (Nomograph)

NOTE

Fill out the enclosed Warranty Registration card and return it to the factory immediately to insure registration and validation of the warranty.

2-2. TUBE AND CHIMNEY INSTALLATION.

WARNING

Tubes and chimneys must be installed and the top cover replaced **BEFORE** any connections are made to the L-4B.

- a. Remove the 6 screws which secure the top cover on the L-4B and remove the cover.
- b. Refer to figure 5-1. Insert both tubes in the sockets on the L-4B chassis. Note the pin arrangement: Pin 3 is isolated.
- c. Install the plate caps on the tubes and secure them with the setscrews provided.
- d. Install the glass chimneys around the tubes. Make sure that all 4 retaining clips are outside each chimney.



- e. Attach one of the parasitic chokes to the top of each of the plate caps with the screws and lockwashers provided. Make sure that the coils of the 2 chokes hang **DOWN**. The word **TOP** stamped on each choke must be visible from the top of the L-4B.
- f. Attach both of the remaining leads on the parasitic chokes to the top of the plate RF choke using the 1/4-20 aluminum screw which also secures one lead from the coupling capacitors. **DO NOT** overtighten this screw.
- g. Replace the top cover and secure it with the 6 screws removed in step a.

2-3. LOCATION.

In general, the location of the L-4B is not critical; however, there are certain considerations which must be given to insure optimum performance. Care should be taken to insure that a space is provided around the Amplifier and Power Supply cases to allow adequate air circulation. Extremely hot locations, such as near radiators or heating units should be avoided. Do not cover the top of either unit with books, papers or other pieces of equipment or overheating may result. The back of the Amplifier case must not be obstructed and should not be placed closer than 1 inch from a wall or the air inlet for the blower will be blocked and overheating of the tubes may occur.

2-4. POWER REQUIREMENTS.

The L-4B is furnished with its own separate Power Supply which can be operated from either 120 VAC or 240 VAC 50-60 Hertz. Because of the large variety of plug and socket configurations for 240 volt service, and because the L-4B can be operated from either 120 Volts or 240 Volts, a line plug is not furnished with the L-4B. The L-4B is shipped from the factory with jumpers connected to operate on 240 VAC. It is highly recommended that the L-4B be operated from its own 240 Volts (15 Amps or greater) circuit. If a 120 Volt circuit is all that is available, it should be fused for 30 Amp and the circuit conductors should not be less than No. 10. No other equipment should be opera-

ted from this circuit. **DO NOT** under any circumstances operate the L-4B from a 120 Volt lighting circuit because the circuit conductors are not large enough to carry this load safely.

2-5. JUMPER CONNECTIONS.

Figures 2-2 and 2-3 are diagrams of jumper connections required for 120 and 240 Volt operation. The jumpers in *both* the Amplifier and Power Supply must be connected as shown or serious damage to the L-4B components may result.

2-6. ANTENNA REQUIREMENTS.

The L-4B has been designed for use with antennas resonant at the operating frequency and having approximate impedances within the limits of 25 to 100 Ohms. The nominal output impedance of the L-4B is 50 Ohms and the SWR of this load should never exceed 2:1. Although there are many types of antennas which will meet these requirements, the simplest is a one-half wave dipole center fed with 52 Ohm coax. For a detailed discussion on antennas, refer to an appropriate antenna book.

2-7. LOW PASS FILTER.

The L-4B has been designed in accordance with good engineering practices and second harmonic content is attenuated from the fundamental by at least 35 dB. Because of the possibility that you may be using a multiband antenna or have a feed line that is resonant at a harmonic frequency, it is highly recommended that a suitable low pass filter such as the R. L. Drake Model TV-1000-LP be used with the L-4B.

2-8. MATCHING NETWORK.

Most practical antennas exhibit an SWR range over a complete amateur band that exceeds 2:1. For this reason we recommend using an antenna matching network such as the R. L. Drake MN-2000 which will allow the L-4B to work into a 50 Ohm load for maximum power transfer into the antenna.

CAUTION

Never attempt to operate the L-4B without first connecting it to an antenna or 50 Ohm Dummy Load of sufficient power handling capacity or serious damage may result.

2-9. GROUND REQUIREMENTS.

For best results, the L-4B should be attached to a good earth ground through as short and as large a ground strap as possible. A binding post is provided on the rear of the L-4B chassis for the ground connection. It is always a good idea to connect the chassis' of all associated equipment together and ground them at one point to avoid ground loops. We recommend that all of the equipment in your station be connected together and grounded at the L-4B Amplifier chassis.

2-10. EXCITER REQUIREMENTS.

To operate the L-4B at the maximum legal input the exciter must provide 100 Watts PEP RF power for SSB operation and 75 Watts RF power for CW, AM, RTTY and TUNE operation. The Drake line of Transceivers and Transmitters all have sufficient power to drive the L-4B to the maximum legal input allowed. Locate the exciter as close to the L-4B as practical to shorten the coaxial cable and ground strap. Refer to figures 2-4 and 2-5 for recommended connection arrangements.

2-11. TRANSMITTING AGC.

The transmitting AGC voltage, which controls the gain of the exciter, is presented at a connector labeled XMTG AGC OUTPUT on the rear of the

L-4B. Any power level can be run up to 2000 Watts PEP without peak clipping. A cable is furnished with the L-4B which provides a connection to the R. L. Drake AC-4 Power Supply. This connection is routed through the AC-4 to the transmitter. An adaptor plug is available from the factory as an accessory for convenience in connecting the AGC and VOX relay cables to an exciter powered by the Drake Model AC-3 Power Supply. Connected to the exciter, this adapter plug brings out the VOX relay contacts, and the AGC connection, and provides a connection to the AC-3 power connector.

2-12. VOX RELAY.

A two pin jack on the rear of the L-4B Amplifier is provided for connection to a pair of normally open relay contacts in the exciter which close on transmit and thus turn on the L-4B at the same time. The L-4B is supplied with a cable to connect this jack to a similar jack on the Model AC-4 Power Supply which terminates in the particular transmitter the AC-4 is powering.

Some exciters, other than the Drake line, ground one of the extra relay contacts made available to key a linear amplifier. For these exciters it is necessary to plug the two pin connector into the L-4B VOX RELAY socket observing the correct polarity. With the exciter in standby, set the L-4B Plate Voltage switch to CW-TUNE, set the ON-OFF switch to ON and pull out the AGC/STANDBY control. Plug in the VOX cable connector and observe the Plate Current Meter. If it reads up scale, reverse the VOX cable connector. The L-4B plate current must be zero with the VOX cable plugged in and the exciter in Standby.

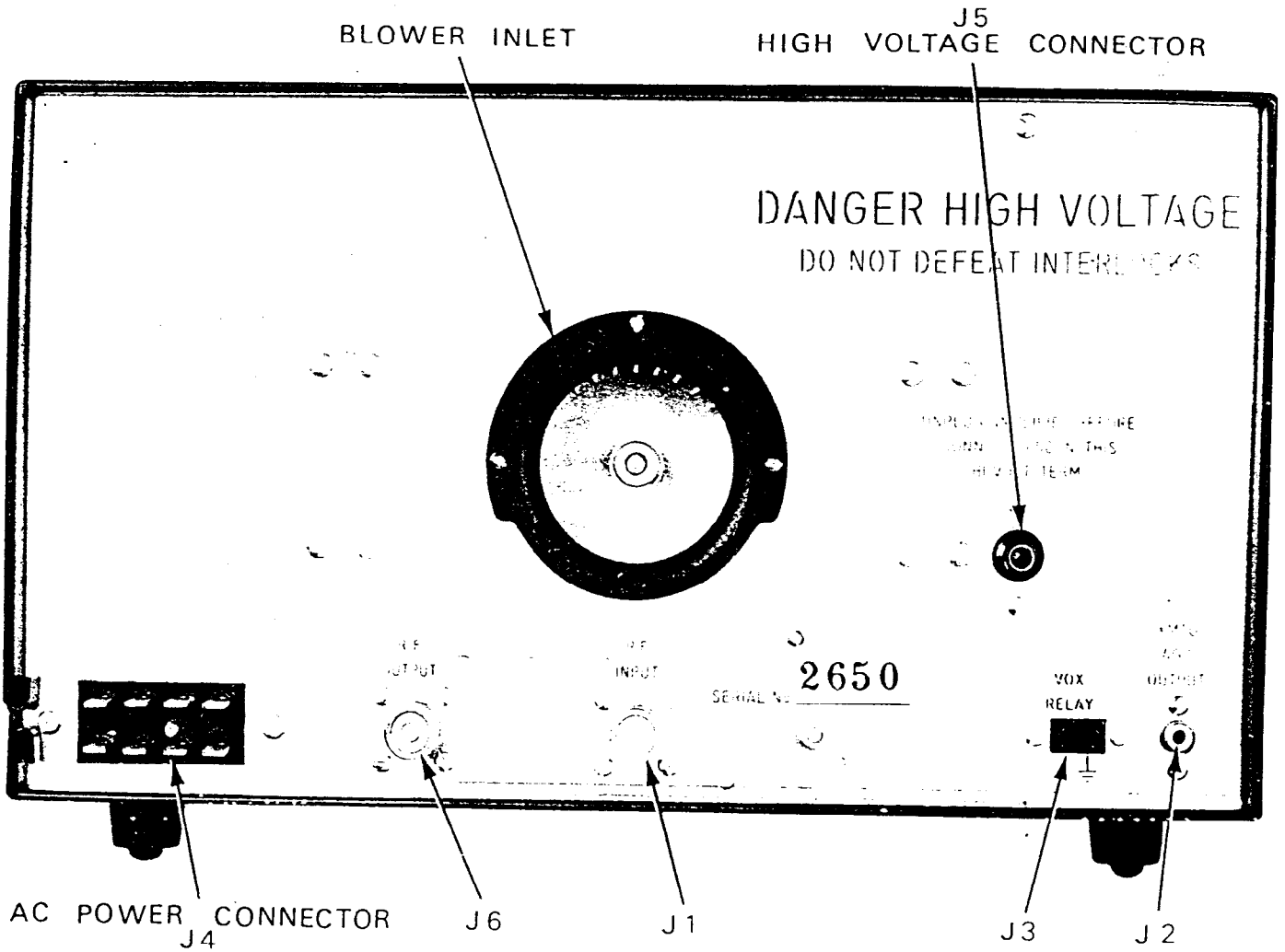
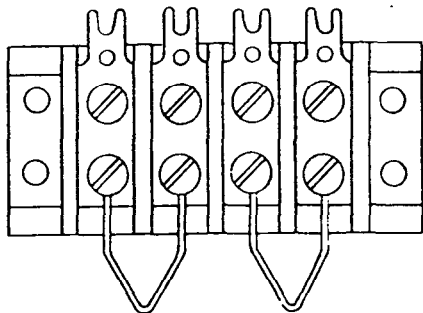

Figure 2-1. Rear Chassis Connectors

120 VOLT OPERATION

Amplifier



Power Supply

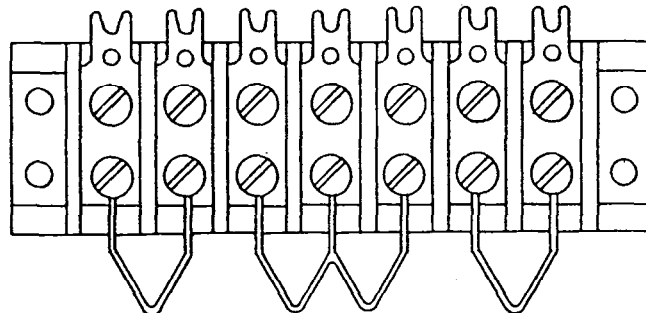
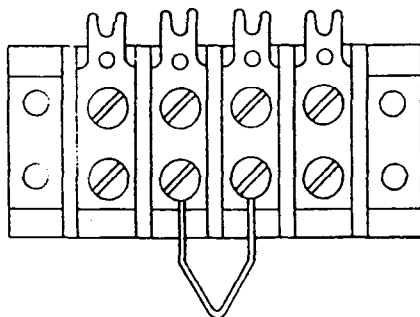

Figure 2-2. Jumper Connections for 120 Volt Operation

240 VOLT OPERATION

Amplifier



Power Supply

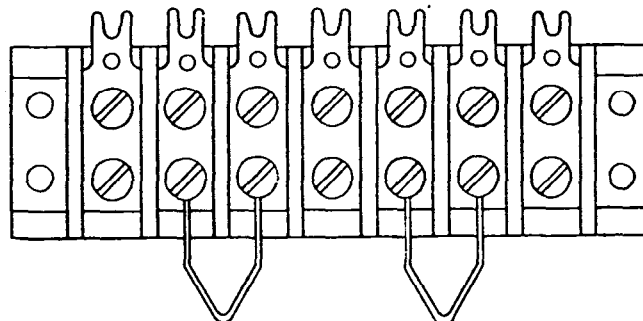

Figure 2-3. Jumper Connections for 240 Volt Operation

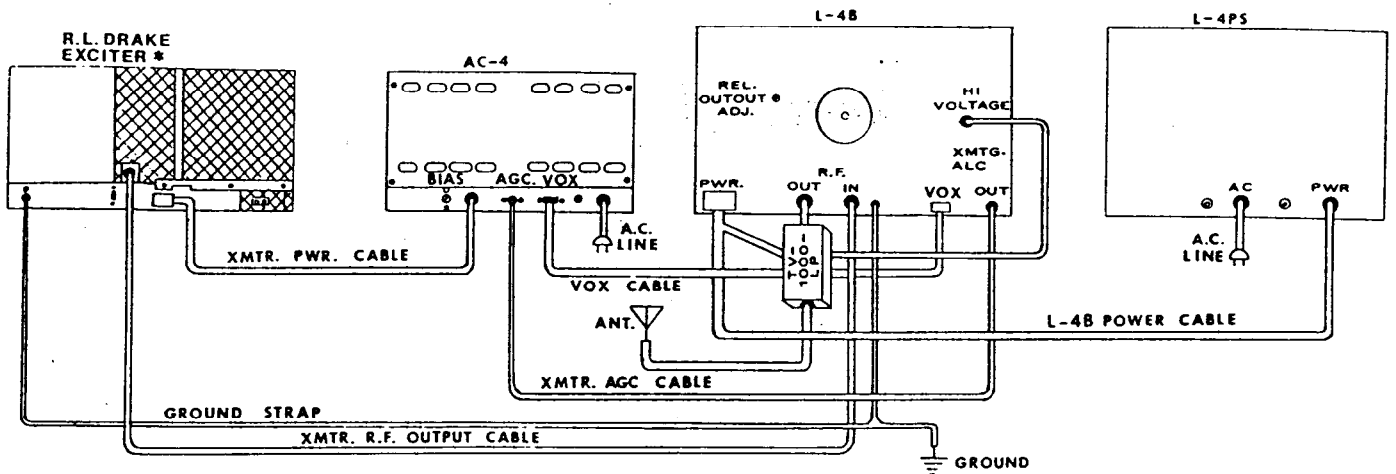
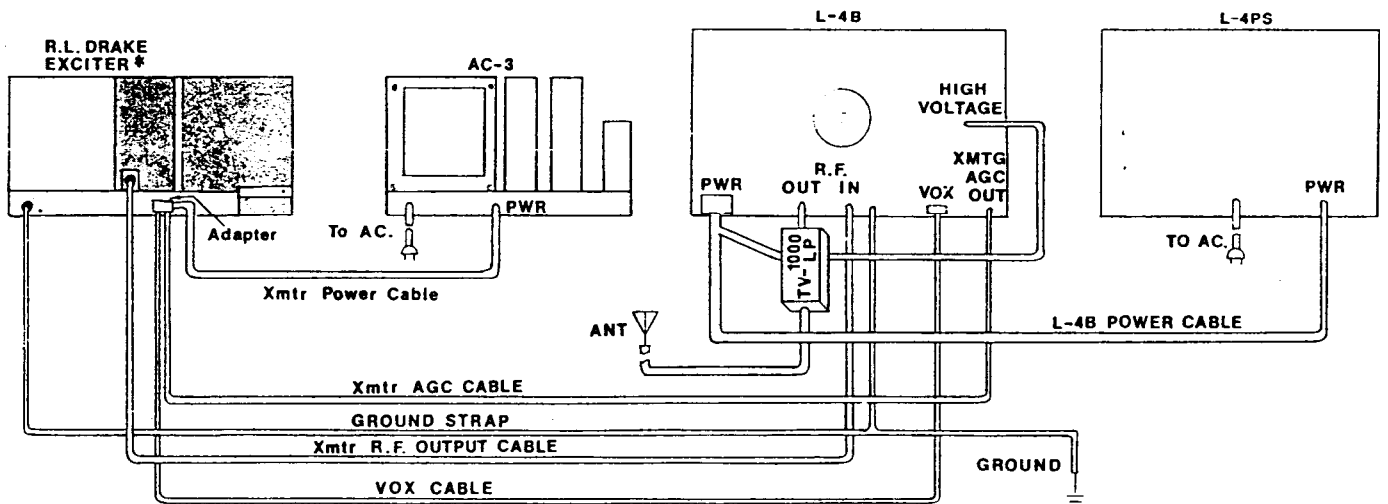

Figure 2-4. Connecting the AC-4 Power Supply and the R. L. Drake Line of Compatible Exciters.



* LIST of EXCITERS
 T-4, T-4B, T-4C, T-4X, T-4XB.
 T-4XC, TR-3, TR-4, TR-4C.

Figure 2-5. Connecting the AC-3 Power Supply and the R. L. Drake Line of Compatible Exciters.

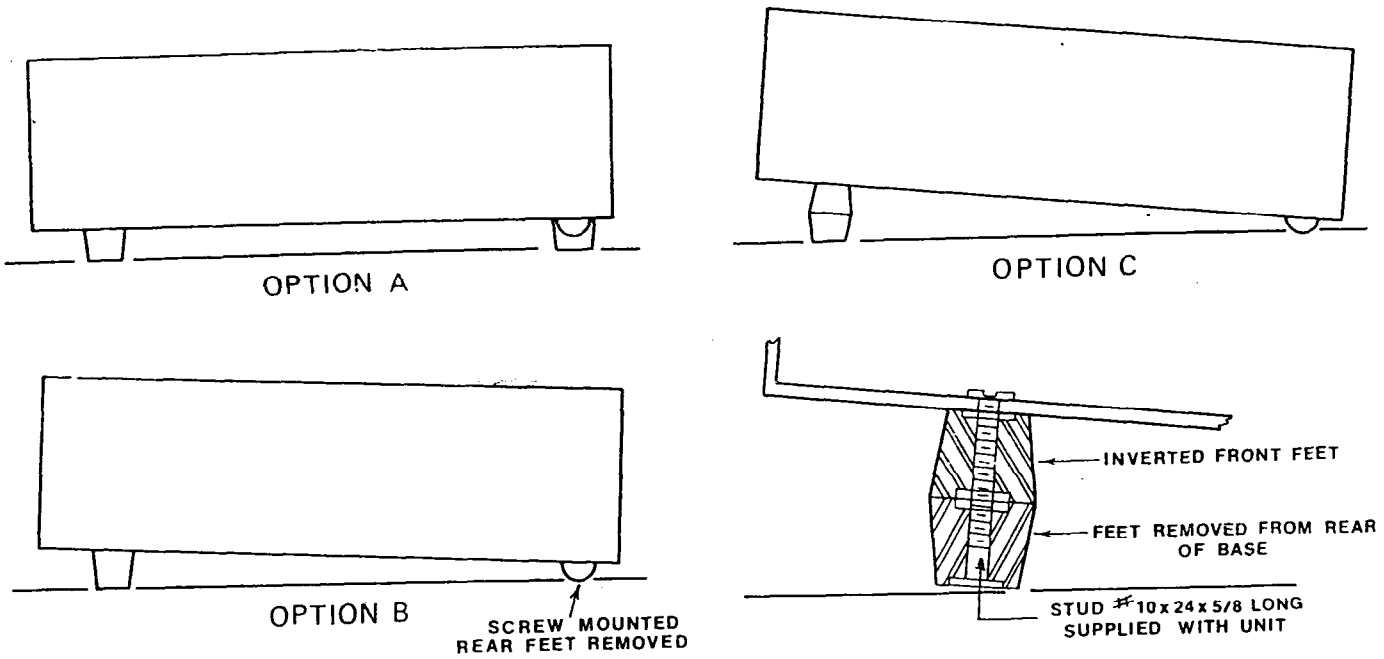

Figure 2-6. Viewing Angle Options

NOTES

CHAPTER III

OPERATION

CAUTION

DO NOT turn on the L-4B Amplifier with the top cover removed because the high voltage interlock shorts out the B+ and will damage Power Supply components. *DO NOT* operate the L-4B Linear Amplifier until it has been connected to a 50 Ohm antenna or a 50 Ohm Dummy Load. Be sure that the correct jumper connections described in Chapter II have been made in both the Linear Amplifier and the Power Supply for the line voltage to be used.

3-1. GENERAL.

Figure 3-1 identifies and describes all front panel controls and indicators referred to in these tuning and operating procedures. Perform the appropriate tuning procedures described below prior to operation.

For all modes of operation, the L-4B is tuned up with a single RF frequency driving it and with the Plate Voltage switch in CW-TUNE position. The exciter may be tuned up on CW into the antenna connected to the L-4B by pushing in the AGC/STANDBY switch. The exciter should be checked to be sure that it is tuned up when driving the L-4B since the antenna connected to the L-4B may not be exactly 50 Ohms.

3-2. TUNING PROCEDURE.

After the exciter has been tuned up, turn the exciter to standby and pull out the AGC/STANDBY switch on the L-4B. Set the Plate Voltage switch (red rocker switch) to CW-TUNE position. The red light that indicates high plate voltage for SSB operation should be off.

Some exciters utilize transmitting AGC, sometimes called ALC, during all modes of operation. During tune up, transmitting AGC will have to be defeated either by unplugging the transmitting AGC connector, or by turning the AGC/STANDBY control fully counterclockwise. All Drake Transmitters and Transceivers except 2-NT (which has no transmitting AGC) switch off AGC in TUNE, CW and AM modes. It is not necessary to defeat AGC externally on Drake Transmitters.

3-3. CW AND RTTY TUNING.

Preset the front panel controls on the L-4B as follows:

- a. Plate Voltage switch to CW-TUNE.
- b. BAND switch to desired band.
- c. Meter switch to 3000 WATTS FWD.
- d. LOAD fully counterclockwise to zero.
- e. PLATE control in the arc provided for the desired band.
- f. Turn AGC/STANDBY control fully counterclockwise and pull out.
- g. ON-OFF switch to ON.

Turn on the exciter and increase the exciter output while not exceeding 0.400 Amperes plate current. Tune the PLATE control for a dip in plate current. Alternately adjust the LOAD and PLATE controls while increasing the exciter power in small increments until maximum RF output occurs at 0.565 plate Amperes. Because of variations in line voltage a graph (figure 3-2) is supplied which correlates plate voltage and plate current for 1000 Watts DC plate input power and should be used to be sure that the L-4B is operating at or under the maximum legal input power. In case maximum legal input cannot be obtained because of low exciter power, tune the L-4B for maximum forward RF Watts at maximum exciter power.

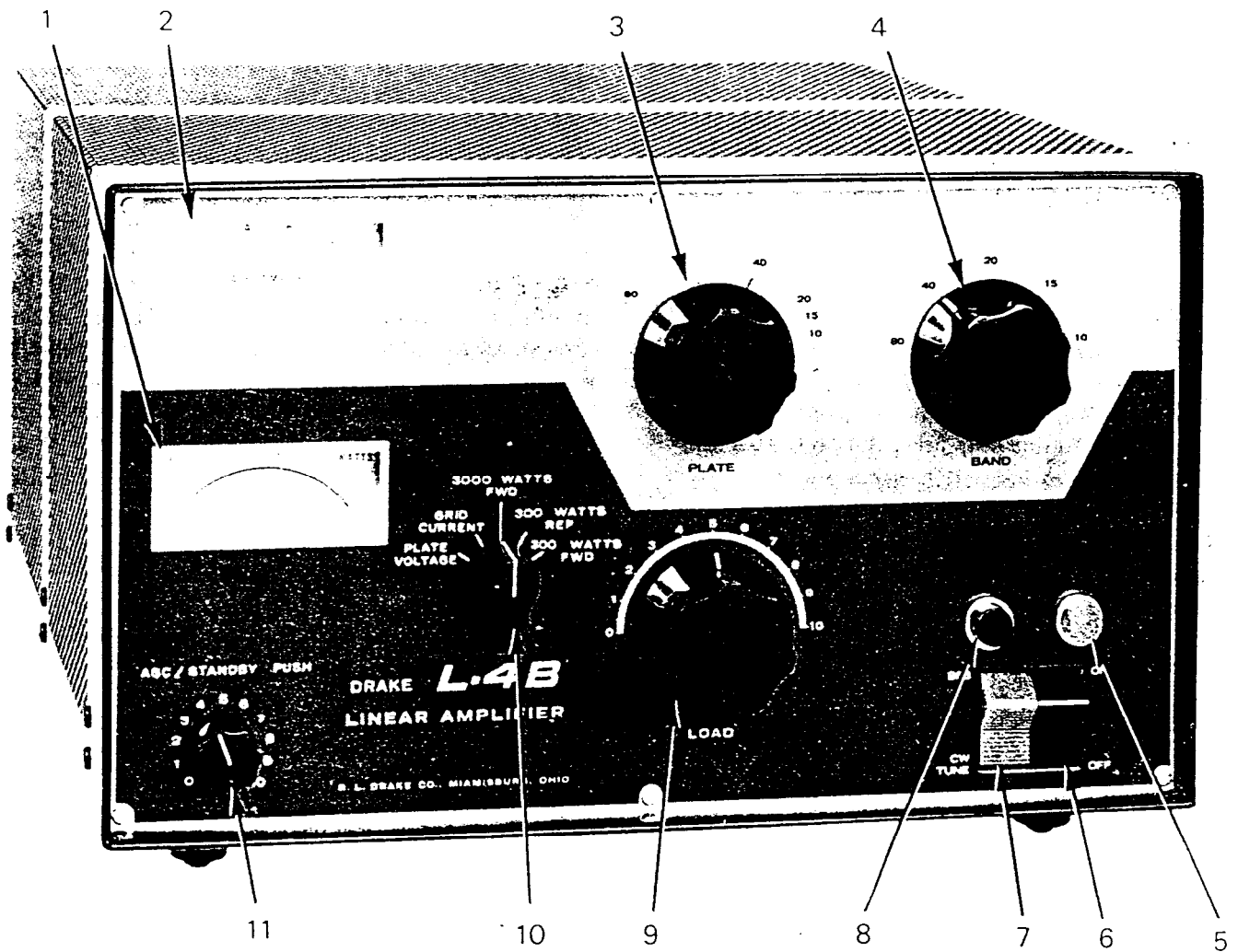

Figure 3-1. Front Panel Controls

1. Multimeter: Indicates grid current, plate voltage and forward or reflected RF power as selected by Meter switch (10).
2. Plate Current Meter: Indicates plate current.
3. PLATE Control: Resonates the plate tank circuit.
4. BAND Switch: Selects input and plate tank components to resonate the amplifier on the amateur band selected.
5. Power Indicator Lamp: Glows orange when power is on.
6. ON/OFF Switch: Turns power on and off.
7. Plate Voltage Switch: Selects high plate voltage for SSB operation or low plate voltage for CW/TUNE operation.
8. SSB Indicator Lamp: Glows red when Plate Voltage Switch (7) is in SSB position.
9. LOAD Control: Adjusts the output impedance of the L-4B to match the antenna load impedance.
10. Meter Switch: Selects display for Multimeter (1).
11. AGC/STANDBY Control: Pulled Out, it allows the L-4B to be controlled by the exciter. Pushed In, it allows the L-4B to stand by and connects the exciter straight through to the antenna. Rotating the control adjusts the transmitting AGC threshold.

3-4. SSB AND AM TUNING.

Preset the front panel controls on the L-4B as follows:

- a. Plate Voltage switch to CW-TUNE.
- b. BAND switch to desired band.
- c. Meter switch to GRID CURRENT.
- d. LOAD control fully counterclockwise to zero.
- e. PLATE control in the arc provided for the desired band.
- f. Turn AGC/STANDBY control fully counterclockwise and pull out.
- g. ON-OFF switch to ON.

NOTE.

Substitute 250 mA grid current for 220 mA in succeeding text if Amperex 8802/3-500Z tubes are installed in the L-4B.

Turn on the exciter and increase the exciter output while not exceeding 0.400 Amperes plate current and tune the PLATE control for a dip in plate current. While increasing the exciter power, maintain 220 mA of grid current with the LOAD control until 0.565 plate Amperes is reached. Leave the exciter power at this level and redip the plate current with the PLATE control and then bring the grid current back to 220 mA with the LOAD control. The L-4B will be very close to being tuned up and only small adjustments of the driving power, and PLATE and LOAD controls will be necessary to obtain 0.565 plate Amperes with 220 mA grid current at resonance.

The forward power meter is a more sensitive indication of plate tank resonance than plate current dip, and the PLATE control should be adjusted for maximum forward power while still maintaining the relationship of 0.565 plate Amperes to 220 mA grid current. In case 0.565 plate Amperes cannot be reached because of low exciter power, tune the L-4B for maximum forward RF Watts at maximum exciter power.

3-5. OPERATION.

NOTE

While transmitting with the L-4B over extended periods of time, the final amplifier plates may show a bright red color. This is normal and does not detract from the life of the tubes. If the plates display a very bright orange color it is advisable to check the L-4B to determine that it is not being overdriven and that it is tuned up properly. The L-4B should not be turned off immediately after long periods of transmitting, but should be left on standby for several minutes with zero plate Amperes to allow the final amplifier tubes to cool down.

3-6. CW AND RTTY OPERATION.

For CW and RTTY operation the Plate Voltage switch should be in CW-TUNE position. With the exciter on and the key depressed, adjust the drive level until the product of plate voltage and plate current is at or under maximum legal input power.

3-7. SSB OPERATION.

For SSB operation the Plate Voltage switch should be in SSB position and the red light that indicates high plate voltage should be on. The transmitting AGC threshold must be set before using the L-4B. With the Plate Voltage switch in CW-TUNE position the transmitting AGC threshold is adjusted by applying a strong single audio tone into the microphone input of the exciter either by an oscillator or by whistling a single tone into the microphone with the exciter adjusted for maximum output. With this single tone applied, turn the AGC/STANDBY control clockwise until the plate current is 0.580 Amperes. If you desire to run less than 2 kilowatts PEP, turn the AGC/STANDBY control clockwise until the single tone plate current decreases to the power level you desire. Return the Plate Voltage switch to SSB. The AGC threshold needs to be set

once on each band. When making large changes in frequency within a band, the L-4B should be checked for plate tank resonance while still maintaining the relationship of 0.565 plate Amperes to 220 mA grid current on CW-TUNE. Under normal voice operating conditions, the exciter should be adjusted to run the L-4B Plate Meter between 0.300 to 0.400 Amperes. Plate current of 0.400 Amperes is the maximum legal input allowed and this level should be reached only occasionally and never exceeded. If the exciter has no provisions for transmitting AGC, the output from the L-4B should be monitored with an oscilloscope to check for peak clipping.

3-8. AM OPERATION.

For AM operation the Plate Voltage switch should be in SSB position and the red light that indicates high plate voltage should be on. The L-4B works quite favorably on AM with the compatible Drake line of Transceivers and Transmitters since these units use controlled carrier modulation. Transmitting AGC is not used on AM with the Drake units and the L-4B output should be monitored with an oscilloscope to check for peak clipping. If the L-4B is to be used with a 100% modulated AM transmitter, the exciter should be adjusted to run the L-4B at 500 Watts DC input with an unmodulated carrier.

3-9. SWR CALCULATION.

The SWR of the load connected to the L-4B can be determined by using the forward and reflected

power readings from the L-4B wattmeter and the SWR calculator supplied with the L-4B. Refer to figure 3-3. The calculator is used by laying a straight-edge across the scales at the L-4B forward and reflected meter readings and reading the VSWR on the center scale at its intersection with the straight-edge. The L-4B wattmeter indicates forward and reflected power at all times, so that SWR can be calculated using only the exciter. For measuring the exciter RF output power a higher degree of accuracy can be obtained by using the 300 Watt forward scale instead of the 3000 Watt scale. When returning the L-4B to service, be sure to return the Meter switch to 3000 Watts or the wattmeter may be damaged. The amount of RF power delivered to the load can be determined by subtracting the reflected power from the forward power.

3-10. OPERATION ON ACCESSORY FREQUENCIES.

<u>Bandswitch Position</u>	<u>Frequency in MHz</u>
80	3.2 - 5.0
40	5.0 - 10.5
20	10.5 - 15.5
15	15.4 - 22.0
10	22.0 - 30.0

The input coils may be retuned for frequencies moderately removed from the amateur bands. For frequencies far removed, it may be necessary to change the values of the capacitors in the input circuit.

1000 Watts D.C. Input
VS
Plate Voltage and Plate Amperes

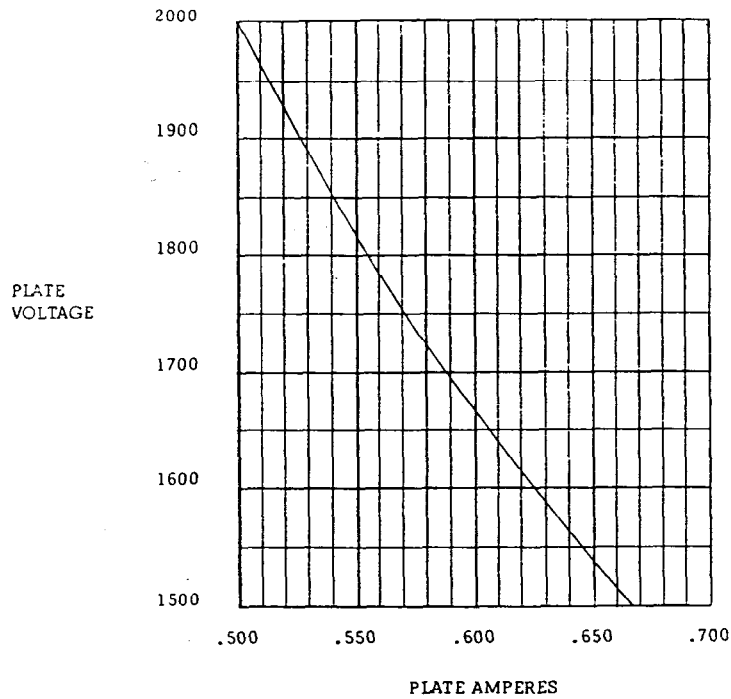

Figure 3-2. Plate Voltage and Plate Current VS 1,000 Watts DC Input Power

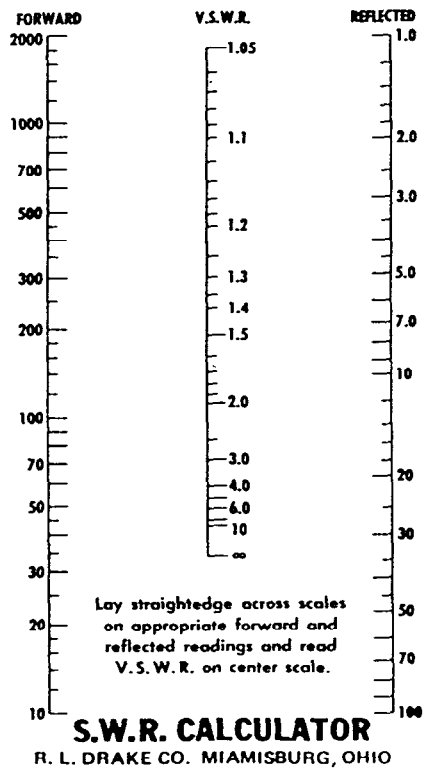

Figure 3-3. SWR Nomograph

CHAPTER IV

THEORY OF OPERATION

4-1. INPUT.

Refer to the schematic diagrams figures 5-4 and 5-5. The 50 Ohm input is matched to the final amplifier cathodes by a pi-network on each band which is selected by the input switch S1a, S1b. The input switch is ganged to the bandswitch S2. Negative feedback in the L-4B amplifier is obtained by slightly raising the grids above ground with capacitors C23, C29, C30, C31, C32 and C37.

4-2. TRANSMITTING AGC.

When the negative-going peak RF voltage from the capacitor divider C24 and C25 exceeds the positive bias set by R3, the transmitting AGC threshold control. D1 conducts and a negative voltage proportional to the RF signal applied to the input appears at the transmitting AGC output connector.

4-3. STANDBY CUTOFF BIAS.

A positive voltage from the resistor divider, R9,

R10 and R11 in the Power Supply is applied to the cathode during standby which cuts off the plate current.

4-4. OUTPUT.

The plate circuit is matched to the 50 Ohm output by the adjustable pi-network consisting of C46, L6, L7, C48, C49, C52, C53 and C56.

4-5. WATTMETER.

The directional wattmeter basically consists of L8, C54, C55 and C57, which take the sum and difference of the transmission line phase voltages and currents to indicate forward and reflected RF power. D3, D4, C59, C60, R15, R17, R18, and R19 rectify, filter and multiply the basic 200 uA movement of the lower front panel meter M2 to indicate forward and reflected RF power.

NOTES

CHAPTER V

MAINTENANCE

5-1. SERVICE DATA.

We will check and align your L-4B at the factory for a nominal fee if it has not been tampered with. Transportation charges are extra. Any necessary repairs will be made on a time and material basis. Please write or call the factory for authorization before returning your unit for alignment or service. Address your request for authorization to:

R. L. Drake Company
540 Richard Street
Miamisburg, Ohio 45342
ATTN: Customer Service Department
Telephone: (Area Code 513) 866-3211
Code-A-Phone Service after
1600 E.S.T.

CAUTION

Do Not ship the L-4B with the tubes and chimneys installed. If the tubes are in question remove them and repack them separately in their original shipping containers or obtain new containers from R. L. Drake Company at the address above. Do not return the chimneys. The R. L. Drake Company will not assume responsibility if the transportation company refuses to pay a damage claim due to improper packing or lack of insurance.

5-2. PARTS ORDERING.

Replacements for any of the components used in the Amplifier or Power Supply may be ordered, at a nominal cost, from the factory at the address above. Parts orders should specify that the parts are for the Amplifier or the Power Supply, the serial number of the unit, schematic reference designation of the part, and value, tolerance and voltage rating, where applicable.

WARNING

DO NOT operate the L-4B with the covers removed. DO NOT defeat the interlock. LETHAL VOLTAGE is present at various points inside the L-4B when the interlock is defeated.

Before disassembling or making any adjustments, perform these precautionary steps in sequence:

1. Disconnect the Power Supply from the power source.
2. Disconnect the AC Power connector from the L-4B.
3. Disconnect the High Voltage connector from the L-4B.
4. Reverse the above order to reassemble the Amplifier.

5-3. AMPLIFIER.

5-4. DISASSEMBLY.

The covers, top and bottom, are secured by 6 screws 3 on each side of the unit. Remove the screws and lift off the covers.

5-5. FRONT PANEL REMOVAL.

The front panel may be removed only when the top and bottom covers are off the Amplifier. The knobs should be removed after the covers, and finally, the front panel may be lifted off after the 6 screws which secure it are removed. Unsolder the leads of the front panel indicator lights from their terminal strip. Tag the leads to insure proper replacement at reassembly. Refer to paragraph 5-21 to reassemble knobs.

5-6. CLEANING.

Since the Amplifier compartment is forced-air cooled, it will collect particles of dust which must be removed periodically. When the blower wheel accumulates a large amount of dust, the Amplifier should be cleaned. The best way to clean the Amplifier is to remove the top and bottom covers and blow the dust out with compressed air. If compressed air is not available, a 1 inch paint brush with soft bristles may be used to brush the interior clean.

5-7. LUBRICATION OF BLOWER MOTOR.

The blower motor should be lubricated once a year with several drops of 10 weight petroleum oil in the front and rear bearing oiler tubes.

5-8. INPUT SWITCH DRIVE BELT REPLACEMENT.

The input switch is linked to the BANDswitch by two pulleys and a bead belt. If the belt needs replacement, it should be done in the following manner:

- a. Set the BANDswitch to 20 meters and remove the top and bottom covers of the Amplifier and remove the front panel.
- b. Loosen the setscrews in the pulley on the BANDswitch shaft and remove the pulley.
- c. Hold the input switch shaft and remove only the pulley on this shaft. If the input switch shaft has been removed, great caution must be taken in replacing this shaft to insure that the rotors are aligned and are not damaged by the shaft insertion forces.
- d. Set the input switch on 20 meters.
- e. With the new belt connecting both pulleys, install the pulleys on their respective shafts at the same time. The copper sleeve on the chain should be midway between the two switch shafts. Before tightening the setscrews on the BANDswitch pulley, check that the input switch is still aligned for 20 meters.
- f. Tighten the setscrews and replace the front panel and Amplifier covers.

5-9. TUBE REPLACEMENT.

If it is necessary to replace the tubes in the L-4B use the same brand and type as the tubes removed or it may be necessary to retune the input circuit as described in paragraph 5-14. If one tube is replaced its replacement should be the same brand and type as the remaining tube.

5-10. TEST EQUIPMENT.

The following list of test equipment represents the minimum required to test and align the L-4B.

- a. Ohmmeter
- b. 50 Ohm SWR Bridge
- c. Standard Milliammeter (400 mA)
- d. RF Wattmeter such as R. L. Drake Model W-4 or an RF Voltmeter such as Hewlett-Packard Model 410B or Boonton Model 91CA.
- e. Transmitter with variable output to 1 kW CW at 14 MHz.
- f. 50 Ohm Dummy Load
- g. 1-1/2 Volt Battery
- h. 10 Ohm Potentiometer
- i. Insulated Alignment Tool

5-11. AMPLIFIER TROUBLESHOOTING.

Careful consideration has been given to the design of the L-4B to keep maintenance problems to a minimum. However, it is quite possible that some problem will arise which cannot be solved by tube substitution. If this occurs, we suggest that you return your unit to your dealer, or write directly to the R. L. Drake Company, Customer Service Department describing your problem in detail. Include full information concerning external connections, control settings, associated equipment and antenna. Be sure to include the serial number of the L-4B.

L-4B PLATE VOLTAGE

CW-TUNE

1900 Volts at No Load 1760 Volts at 0.565 Amps

SSB

2600 Volts at No Load 2400 Volts at 0.800 Amps

L-4B IDLING PLATE CURRENT

TUBES	CW-TUNE	SSB
Amperex 8802/3-500Z	0.100 Amps	0.160 Amps
Amperex 8163	0.100 Amps	0.160 Amps
Eimac 3-400Z	0.110 Amps	0.170 Amps
Eimac 3-500Z	0.170 Amps	0.260 Amps

All tubes above are directly interchangeable in the L-4B and are capable of operating the full legal limit for amateur service. All voltages and currents listed above bear a 10% tolerance for tube and line voltage variations.

5-12. TUBE CHECK.

A common failure in the final amplifier tubes is a filament-to-grid short which is usually intermittent. This failure may be detected by the incidence of negative grid current (and usually some plate current) during standby. Check each suspect tube as follows:

- Observe the WARNING in paragraph 5-2 and remove the tubes.
- Attach an ohmmeter between the grid and filament of the tube to be tested. Good tubes will indicate infinite resistance. Bad tubes will indicate a short circuit. Intermittent tubes will indicate a momentary short when tapped lightly.

5-13. ALIGNMENT PROCEDURES.

Refer to figures 5-1 and 5-2 as required to locate the components requiring adjustment.

5-14. INPUT COIL ADJUSTMENT.

The input coils may have to be retuned if the final amplifier tubes are replaced with a type different from the tubes removed. Also, they may have to be retuned if it is desired to operate the L-4B outside the amateur bands. To retune the input coils proceed as follows:

- Disconnect the L-4B Power Supply from the power source.
- Remove the bottom cover from the Power Supply.
- Remove all of the jumpers from the 7-terminal barrier strip in the power supply. This allows the filaments, relay power and blower to operate without the high voltage being on.
- Remove the top cover from the Amplifier. DO NOT defeat the interlock.
- Connect the Amplifier to the exciter as for normal operation EXCEPT: insert a 50 Ohm SWR bridge in the line (R. L. Drake W-4 or equal).
- Preset the L-4B controls as follows:
BAND: on band to be tuned.
LOAD: fully counterclockwise to zero.
PLATE: in the arc for the desired band.
AGC/STANDBY: pulled out.
ON-OFF to OFF.
- Tune the exciter, on CW, to the middle of the band to be tuned.
- Reconnect the Power Supply to the power source.
- Turn on the L-4B and increase the output from the exciter until the Plate meter reads 0.400 Amperes.
- Tune the PLATE control for a dip in plate current.
- Refer to figure 5-1. Turn the slug in the correct input coil for a minimum reflected power reading on the SWR bridge.
- Repeat steps f through k for each coil to be retuned.

NOTE

As shipped from the factory, the input coils are adjusted for the center of each band and are broad enough to cover the entire band. When the coils are tuned on the amateur band the slugs are near the top of their travel.

- Turn off the L-4B, disconnect the Power Supply from the power source, replace the jumpers removed in step c above, remove the SWR bridge and replace the covers on the Power Supply and the Amplifier before resuming operation.

5-15. METER ADJUSTMENT.

To adjust the meters on the front panel of the L-4B proceed as follows:

- a. Disconnect the Power Supply from the power source.
- b. Remove all connections to the L-4B Amplifier.
- c. Remove the covers and the front panel from the L-4B. When replacing the front panel knobs refer to paragraph 5-21.
- d. Each meter has a conventional zero-adjust screw on the lower face of the meter and may be set to zero with that screw.
- e. If the lower meter M2 or resistor R8 is replaced the grid current shunt R16 will have to be calibrated as follows:
 1. Defeat the interlock by placing a book on top of the operating rod (NO CONNECTIONS TO L-4B).
 2. Set the Meter switch to GRID CURRENT.
 3. Make the connections shown in figure 5-3.
 4. Adjust the 10 Ohm pot until the milliammeter indicates 0.400 Amperes.
 5. Adjust R16 until the Grid Current meter indicates 400 mA.
 6. Disconnect the test network.
- f. If a milliammeter is not available, an alternate method of calibrating R16 is as follows:
 1. Defeat the interlock (NO CONNECTIONS TO L-4B).
 2. Reverse the wires connected to the Plate Meter M1.
 3. Connect a 1-1/2 Volt battery (negative to ground) in series with a 10 Ohm potentiometer to pin 6 of the Power connector J4 on the rear of the L-4B.
 4. Adjust the 10 Ohm pot until the Plate Meter indicates 0.400 Amperes.
 5. Adjust R16 until the Grid Current Meter indicates 400 mA.
 6. Disconnect the test network and reverse the wires on the Plate Meter to their original locations.

5-16. WATTMETER CALIBRATION.

The wattmeter in the L-4B was designed to keep maintenance to a minimum. The wattmeter is a passive device and it should provide years of service and maintain its calibration. If calibration becomes necessary, paragraphs 5-17 through 5-21 must be followed in sequence.

5-17. NULL ADJUSTMENT.

WARNING

When making adjustments to the Wattmeter with the exciter on, exercise **EXTREME CAUTION** to avoid RF burns. Avoid touching the Piston Trimmer C54, the Antenna Changeover Relay K1 and all wires connected to it.

- a. With the L-4B completely disconnected, turn it upside-down and remove the bottom cover.
- b. Connect the exciter to the RF INPUT and the 50 Ohm Dummy Load to the RF OUTPUT.
- c. Set the L-4B Meter switch on 300 WATTS REF.
- d. Apply between 100 and 300 Watts of power at 14 MHz.
- e. With the insulated alignment tool adjust the piston trimmer C54 for a minimum indication of reflected power.
- f. All further adjustments should be made with the L-4B in its normal upright position.

5-18. 300 WATTS REFLECTED.

- a. Connect the exciter to the RF OUTPUT and the RF INPUT to a Wattmeter (Drake W-4) and then to a 50 Ohm Dummy Load.
- b. Set the Meter switch to 300 WATTS REF and apply 300 Watts from the exciter. If 300 Watts is not available, adjust the exciter for maximum RF output.
- c. Adjust R18 so that the L-4B wattmeter agrees with the standard wattmeter or with the RF power calculated from the RF voltage measured across the 50 Ohm load.

5-19. 300 WATTS FORWARD.

- a. Connect the L-4B as in the null adjustment (paragraph 5-17), and include a wattmeter (Drake W-4) between RF OUTPUT and the 50 Ohm load. Place the Meter switch on 300 WATTS FWD and apply 300 Watts from the exciter. If 300 Watts is not available, adjust the exciter for maximum RF output.
- b. Adjust R15 so that the L-4B wattmeter agrees with the standard wattmeter or with the RF power calculated from the RF voltage measured across the 50 Ohm load.

5-20. 3000 WATTS FORWARD.

- a. After the 300 Watts forward calibration, place the Meter switch in the 3000 WATTS FWD position and apply 1000 Watts from the exciter. If 1000 Watts is not available, adjust the exciter for maximum RF output.
- b. Adjust R19 so that the L-4B wattmeter agrees with the standard wattmeter or with the RF power calculated from the RF voltage measured across the 50 Ohm load.

5-21. KNOB POINTER ALIGNMENT.

When replacing the knobs on the L-4B amplifier, correct alignment of the PLATE and LOAD controls is important. All of the other controls have flats on the control shafts and the setscrews in the knobs should press against the flats. The LOAD control shaft should be rotated fully counterclockwise and

the knob pointer resting on zero before the set-screw is tightened. The PLATE control shaft should be rotated so that the plates of C46 are fully meshed and the pointer should be resting in a nine o'clock position at the end of the tuning arc. The PLATE control knob is set by tuning up the L-4B on 21.225 MHz 1000 Watts CW. After tune-up hold the PLATE tuning knob with one hand and push the indicator to the 15 meter segment of the tuning arc with the other hand.

5-22. POWER SUPPLY.

5-23. CIRCUIT BREAKER RESET.

There are two buttons on the power supply which are provided for resetting the circuit breakers in case they should trip from overloading. If the circuit breakers trip, turn off the L-4B and wait for one minute before resetting. If the circuit breakers trip immediately after resetting and turning the L-4B on, an investigation should be made to determine the cause of the overload.

5-24. REMOVING BOTTOM COVER.

WARNING

BE SURE that the L-4B Power Supply is unplugged from its power source.

After completely disconnecting all sources of power, the bottom cover of the Power Supply can be removed by taking out all of the screws around the bottom of the chassis.

5-25. REMOVING TOP COVER.

WARNING

BE SURE that the L-4B Power Supply is unplugged from its power source.

The top cover cannot be removed until the bottom cover has been removed. After the bottom has been removed, remove the line cord wires from the barrier strip and ground. The top can then be removed by taking out the remaining screws holding the top cover to the chassis.

5-26. POWER SUPPLY TROUBLESHOOTING.

Careful consideration has been given to the design of the L-4B Power Supply to keep maintenance problems to a minimum. However, if the Power Supply fails to function, first check the circuit breakers and reset them if it is necessary. If the

circuit breakers continue to trip, check for short circuits in the high voltage line. Especially be certain that the high voltage interlock in the Amplifier is not shorting the high voltage to ground as it is supposed to do when the top cover is taken off the Amplifier. If the circuit breakers have been tripped because of a short in the high voltage line, a continuity check should be given to each silicon diode bank in the Power Supply to determine if either or both banks have failed. In the event of a short circuit, resistor R12 in the Power Supply will be destroyed. This resistor protects the diodes in the Power Supply and it should be replaced with an IRC 0.82 Ohm 2 Watt type BWH resistor ONLY. In the event of difficulty, we recommend that you return your unit to your dealer, or write directly to our Customer Service Department describing your problem in detail. Include full information concerning the circumstances during the failure, any measurements that were made and be sure to include the serial number.

PARASITIC
CHOKES(PC-1, PC-2)

RF/PLATE
CHOKE(RFC-4)

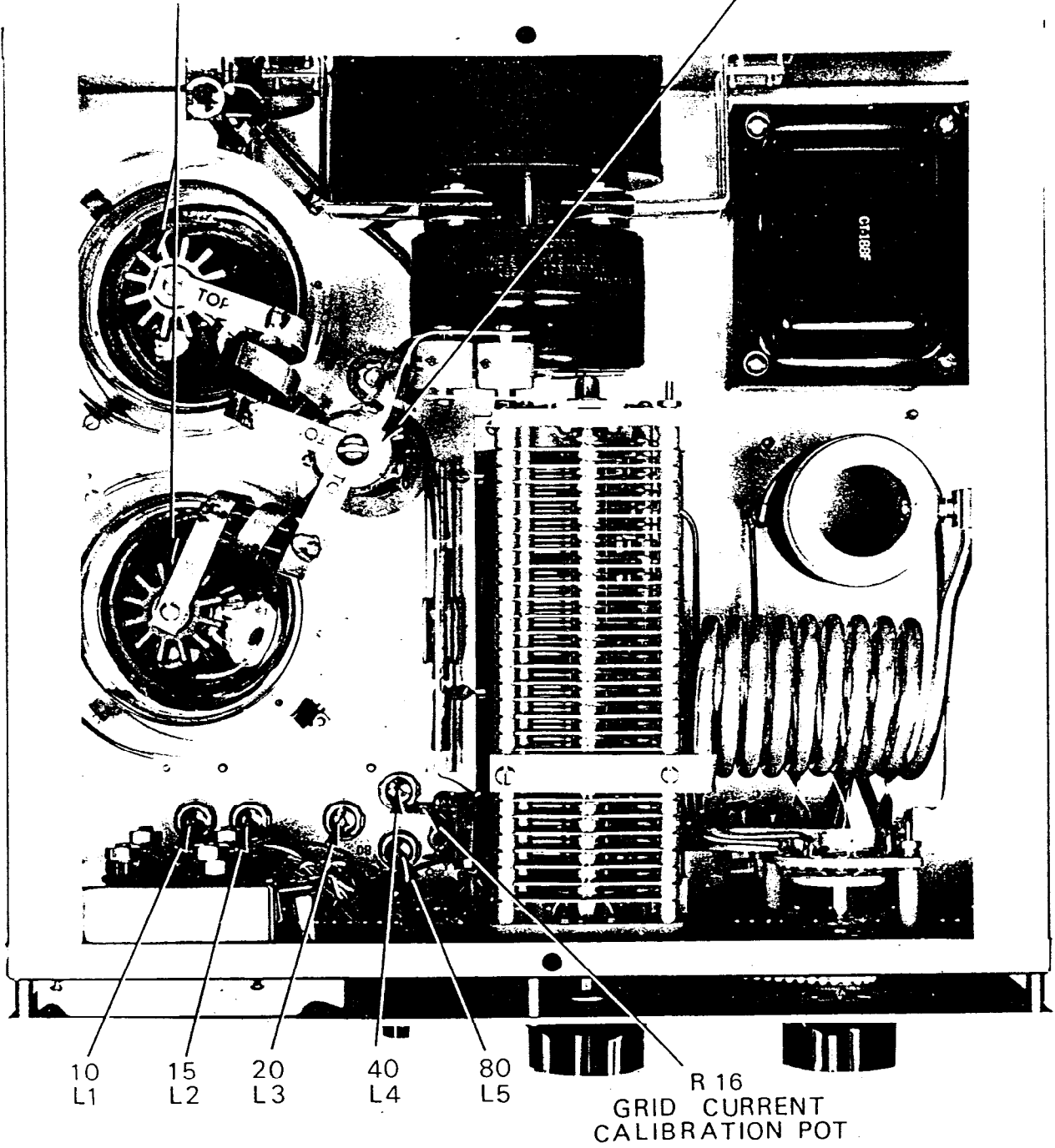
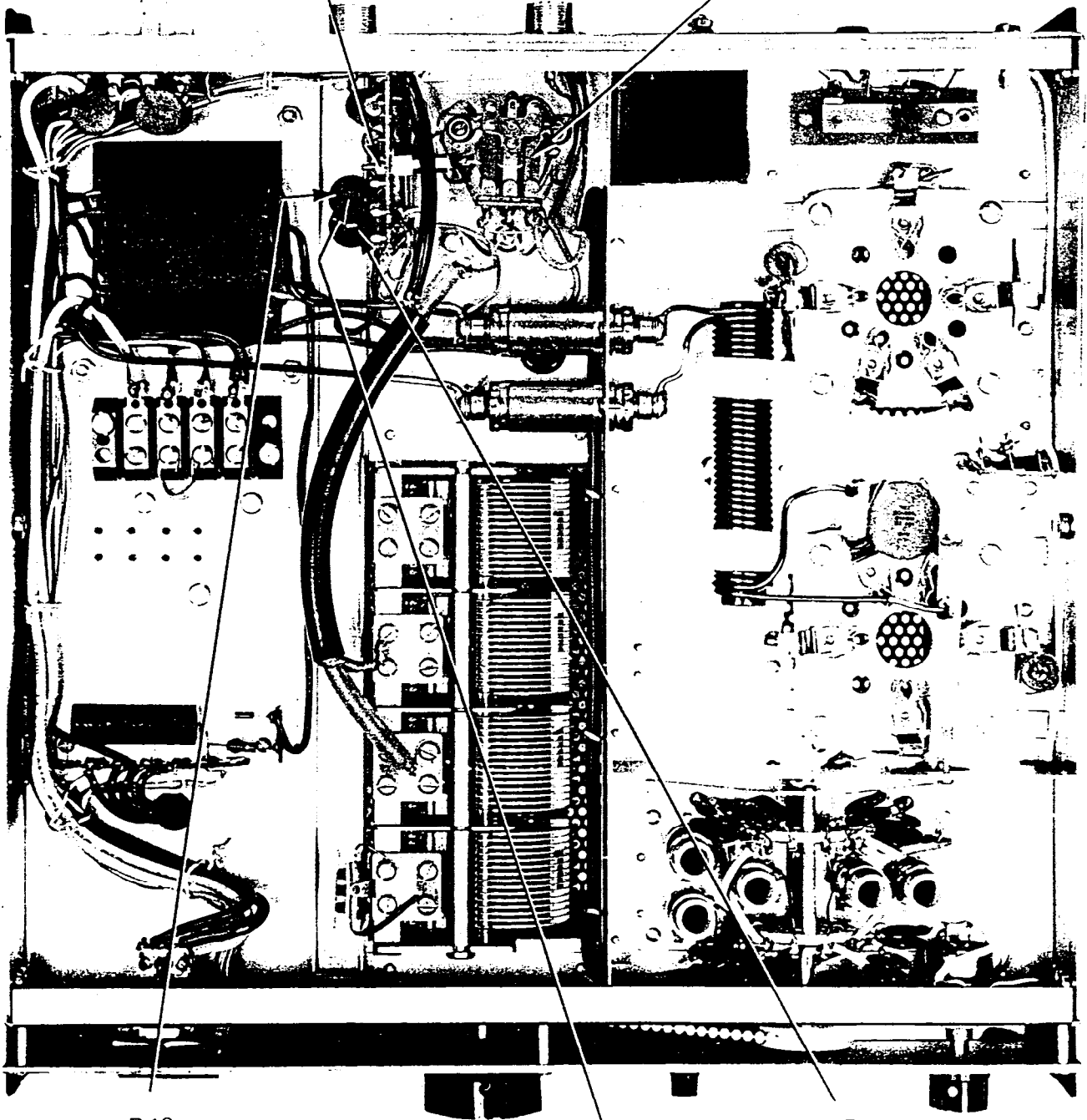

Figure 5-1. Component Locations, Top View

C54
PISTON TRIMMER

ANT CHANGEOVER
RELAY (K1)



R19
3000 WATT FORWARD
CALIBRATION POT

R18
300 WATT REFLECTED
CALIBRATION POT

R15
300 WATT FORWARD
CALIBRATION POT

Figure 5-2. Component Locations, Bottom View

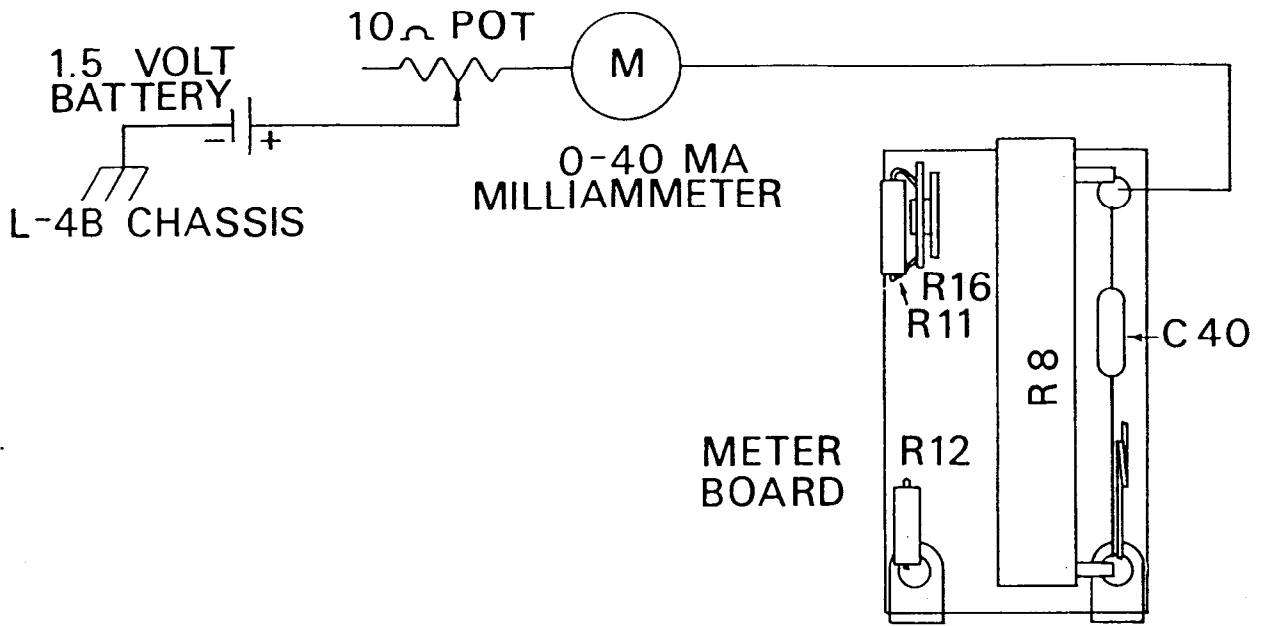
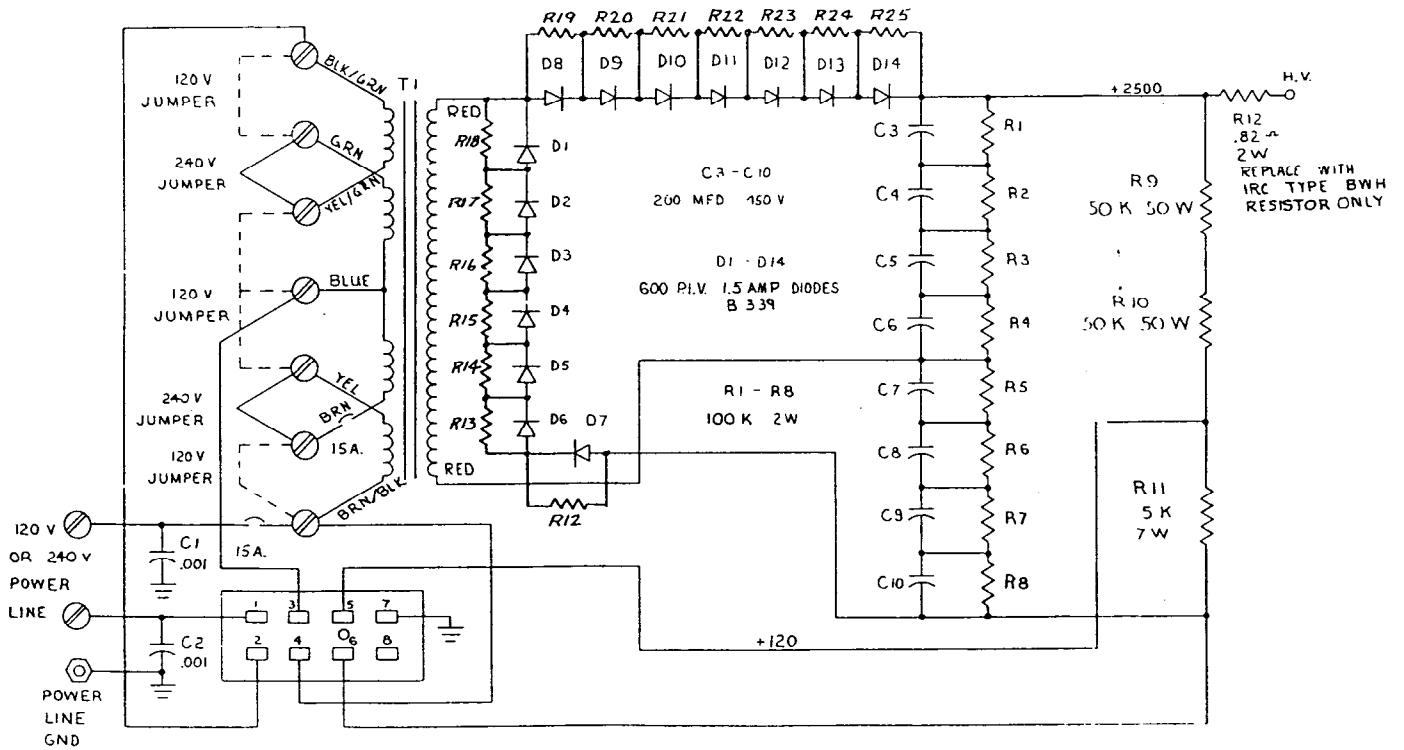

Figure 5-3. Connections for Grid Current Meter Calibration



POWER CONNECTOR SHOWN FROM SOLDER CONNECTION END

42268801

Figure 5-4. Model L-4B Power Supply Schematic Diagram

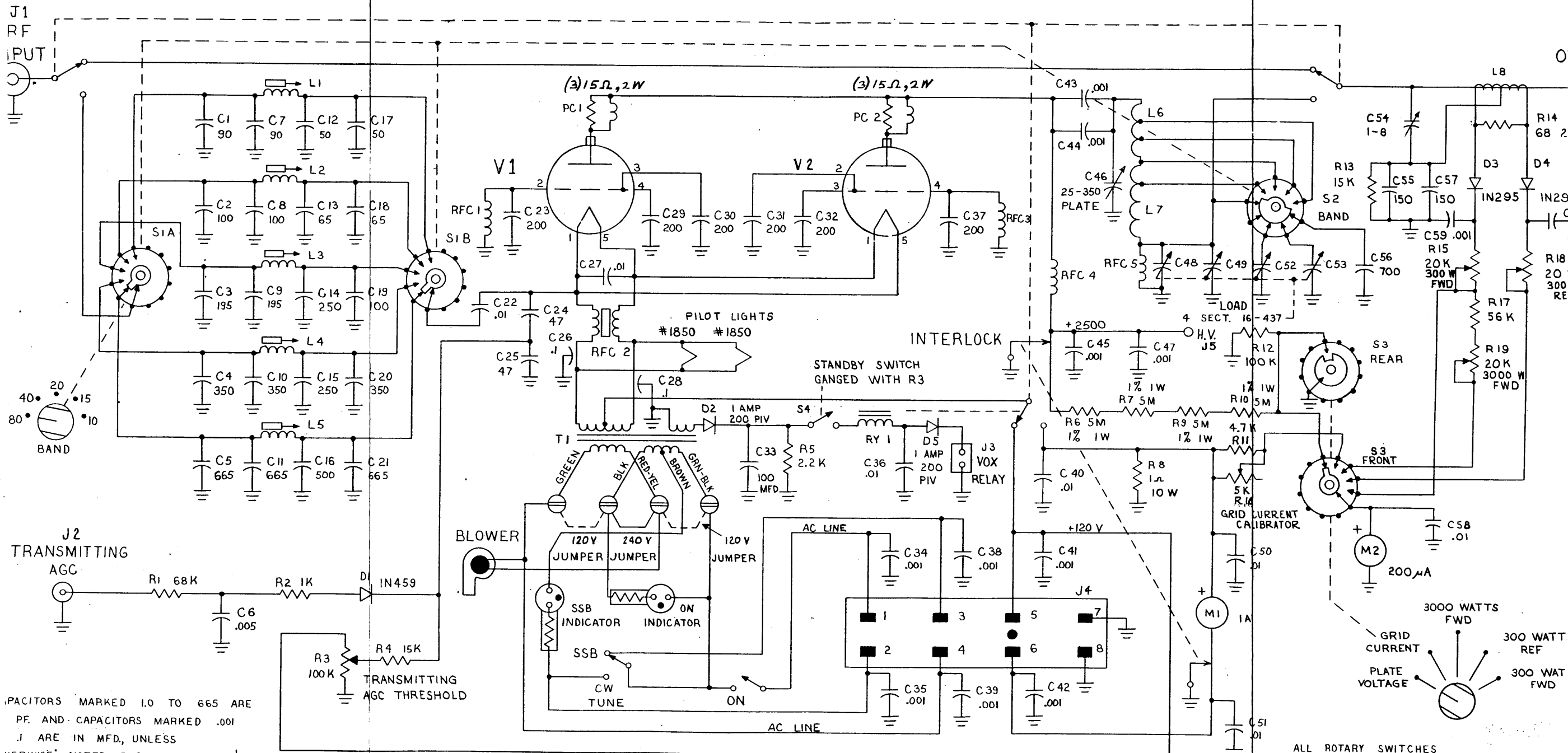

CAPACITORS MARKED 1.0 TO 665 ARE
 P.F. AND CAPACITORS MARKED .001
 .1 ARE IN MFD, UNLESS
 OTHERWISE NOTED. RESISTORS ARE $\frac{1}{2}$
 WATT 10% EXCEPT WHERE NOTED.
 SHOWN OUTSIDE VIEW.
 CHEAPEST RESISTOR R19
 CHEAPEST CAPACITOR C60

801691301

ALL ROTARY SWITCHES
 ARE SHOWN LOOKING
 INTO SHAFT AND IN
 FULLY CCW POSITION.

Figure 5-5. Model L-4B Linear Amplifier Schem.

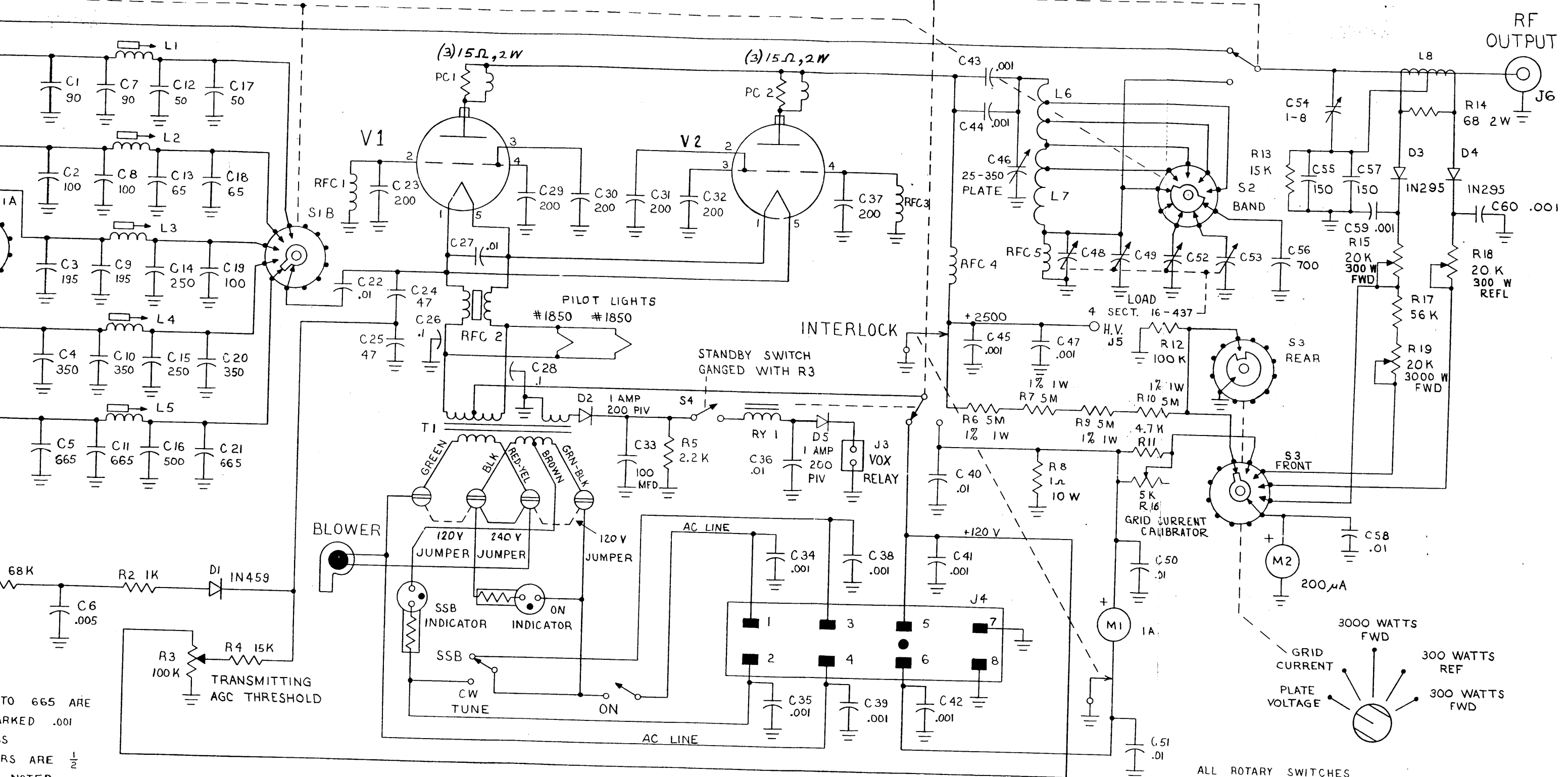

TO 665 ARE
 MARKED .001
 S
 RS ARE 1/2
 NOTED.

ALL ROTARY SWITCHES
 ARE SHOWN LOOKING
 INTO SHAFT AND IN
 FULLY CCW POSITION.

801691301

Figure 5-5. Model L-4B Linear Amplifier Schematic Diagram